

GAUGE SIPHONS GSC - GSU

DESCRIPTION

The GS series pressure gauge siphons have been designed to protect pressure gauges from the effect of rapid pressure surges and hot pressure fluids.

They operate as cooling elements for liquids and gases in pressure measuring devices.

An isolation pressure gauge cock is recommended to be installed in combination with gauge siphons.

MAIN FEATURES

Complete stainless steel construction

OPTIONS: Different kind of connections.

USE: Pressure gauge protection on steam, water, compressed air and other fluids systems compatible with the construction.

AVAILABLE MODELS: GSC-40; GSU-40 ; GSUL-40

SIZES : ½" (male x female)

CONNECTIONS: Female screwed ISO7/1Rp(BS21)

INSTALLATION: GSC - vertical: GSU - horizontal.

LIMITINNG CONDITIONS: 40 bar at 300 °C; 110 bar at 110 °C

WEIGHT: 0,34 Kgs

MATERIALS: Coil – AISI 316L / 1.4404
Connections – AISI 304 / 1.4301



GSC



GSU



GSUL

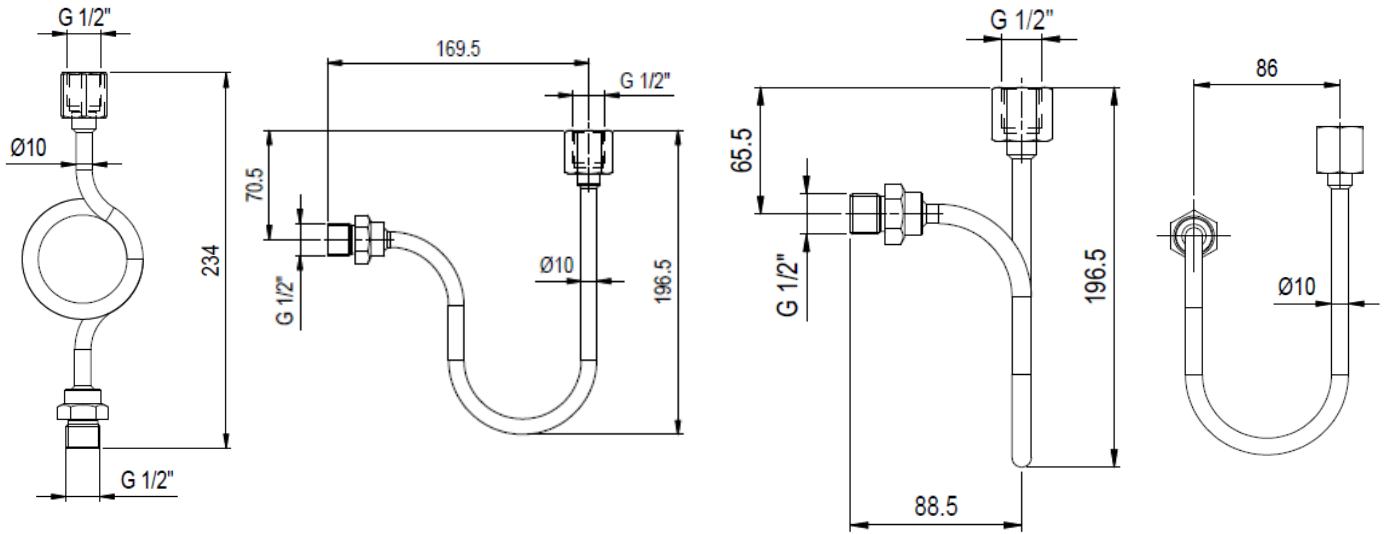

Typical Installation

Horizontal pipes

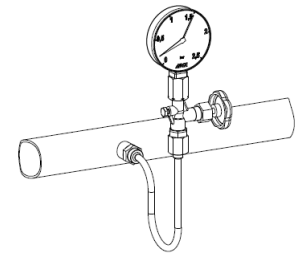
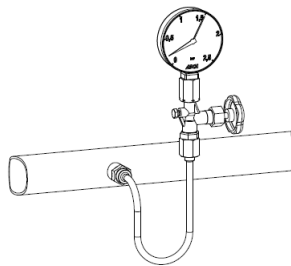
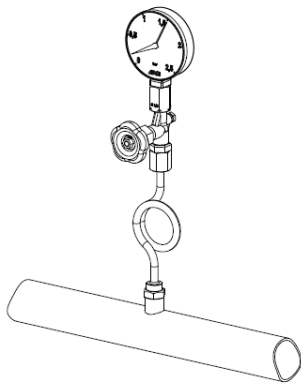

Vertical pipes

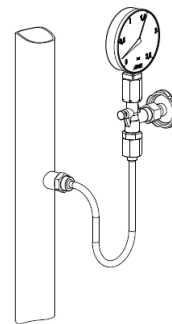
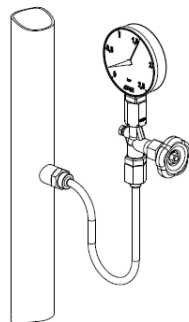

Top of vessel

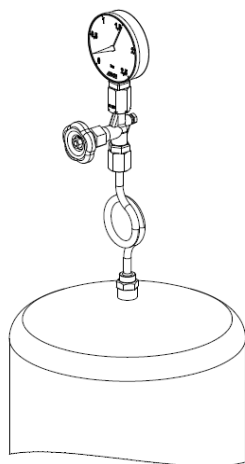

Side of vessel

